

# OutDoor by ISPO 2024

Stand packages &  
participation prices

**OutDoor**  
by ISPO

## Package

# Full-Service 15 (15sqm)

**6.529,00 EUR**

## Services

- Pre-built system NATIVE
- 1 Power socket
- IP connection - symmetrical 10 Mbit/s
- Carpet
- 1 Pinboard
- 1 Media Rack
- 2 Presentation & Working Tables
- 2 Bar stools
- 1 Monitor 40" for memorystick
- 1 standard typo company name
- Lighting
- including AUMA fee & Stand cleaning

## Tickets

Access to Invitation Tool  
„Connect by ISPO“  
with **unlimited ticket** voucher  
**3 Exhibitor passes**

## Obligatory Communication fee

Basic entry in the digital exhibitor listings „Company profile“ including company name, address, website, four entries in the product index

Company profile and filter options according to products

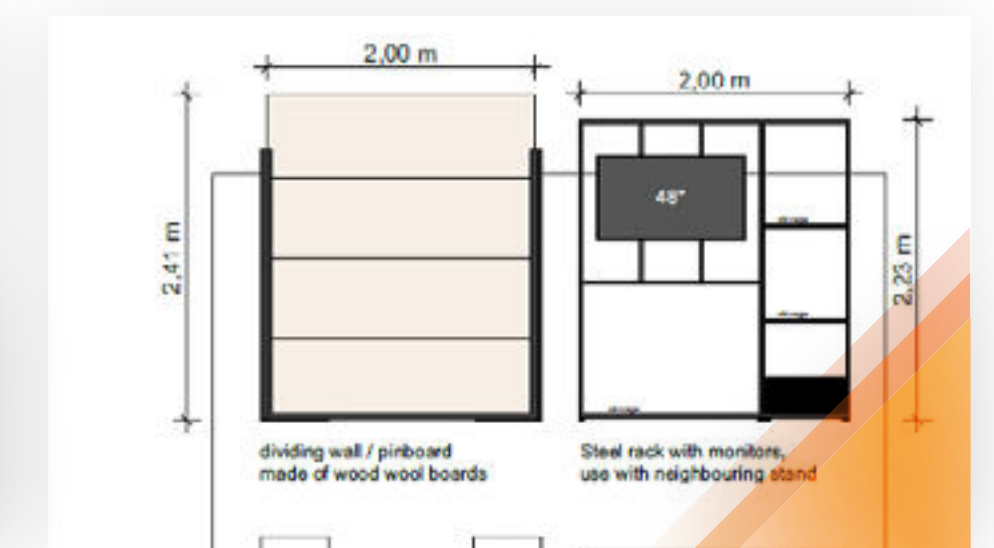
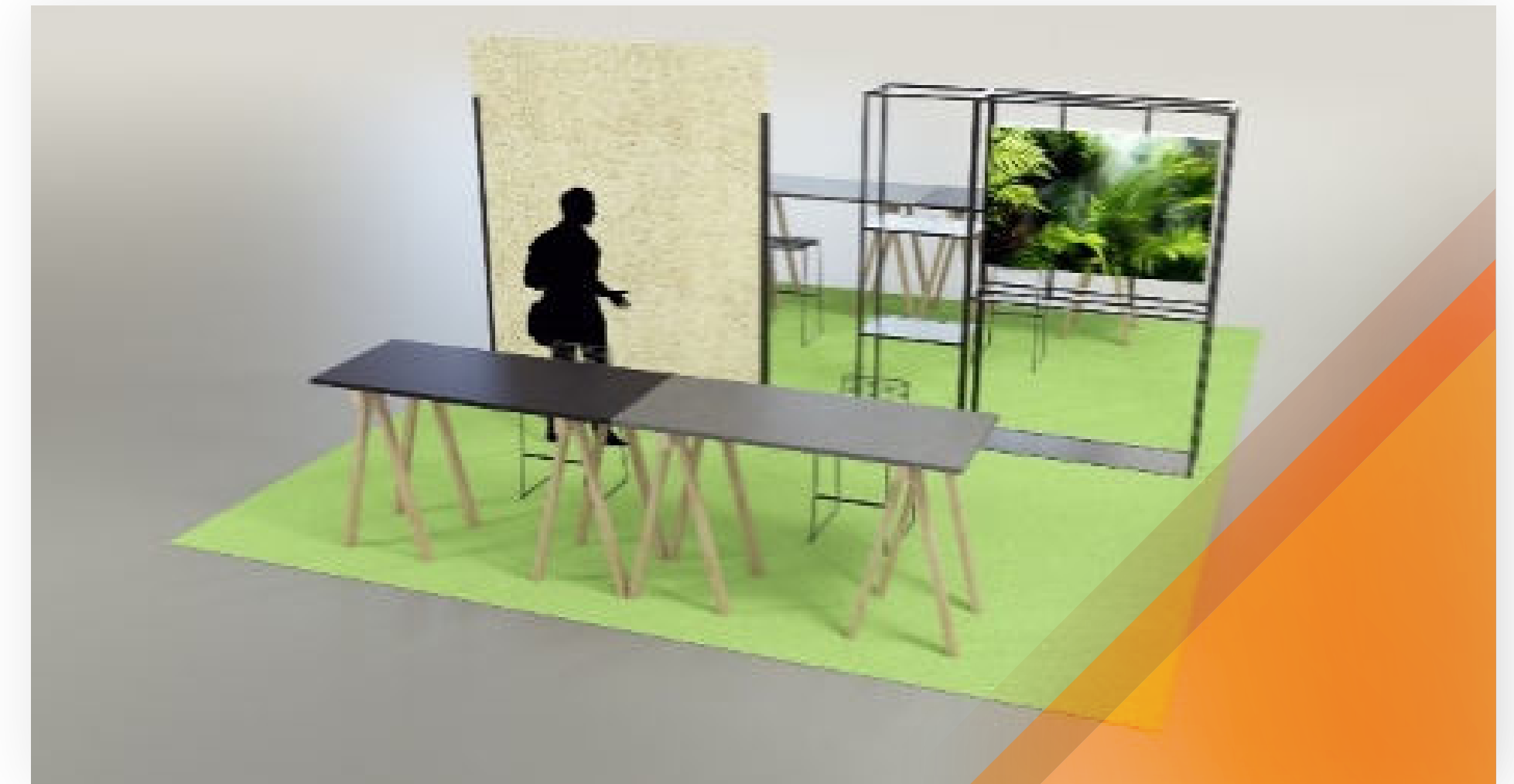

## Package

# Full-Service 30 (30sqm)

**11.229,00 EUR**

## Services

- Pre-built system NATIVE
- 1 Power socket
- IP connection - symmetrical 10 Mbit/s
- Carpet
- 2 Pinboard
- 1 Media Rack
- 2 Presentation & Working Tables
- 2 Bar stools
- 1 Monitor 40" for memorstick
- 1 standard typo company name
- Lighting
- including AUMA fee & Stand cleaning

## Tickets

Access to Invitation Tool  
„Connect by ISPO“  
with **unlimited ticket** voucher  
**3 Exhibitor passes**

## Obligatory Communication fee

Basic entry in the digital exhibitor listings „Company profile“ including company name, address, website, four entries in the product index

Company profile and filter options according to products

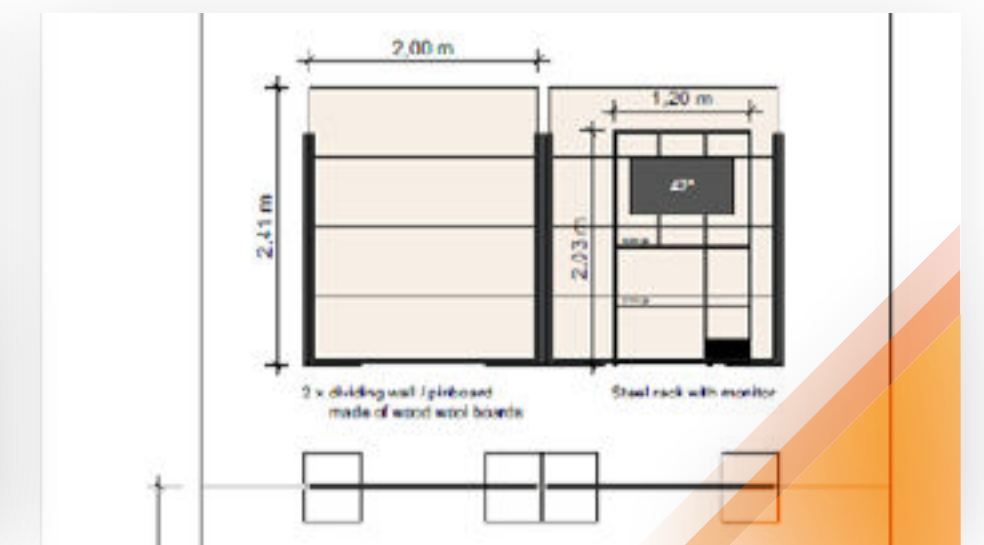

## Package

# Full-Service 45 (45sqm)

**15.529,00 EUR**

## Services

- Pre-built system POLYGON 1,80 m
- 1 Power socket
- IP connection - symmetrical 10 Mbit/s
- no carpet - tape outline
- 1 Graphic space / Flap 160 cm
- Fixings at choice according to catalog/additional costs
- 2 Seating groups
- 1 Monitor 40" for memystick
- 1 standard typo company name
- Lighting
- including AUMA fee & Stand cleaning

## Tickets

Access to Invitation Tool  
„Connect by ISPO“  
with **unlimited ticket** voucher  
**3 Exhibitor passes**

## Obligatory Communication fee

Basic entry in the digital exhibitor listings „Company profile“ including company name, address, website, four entries in the product index

Company profile and filter options according to products

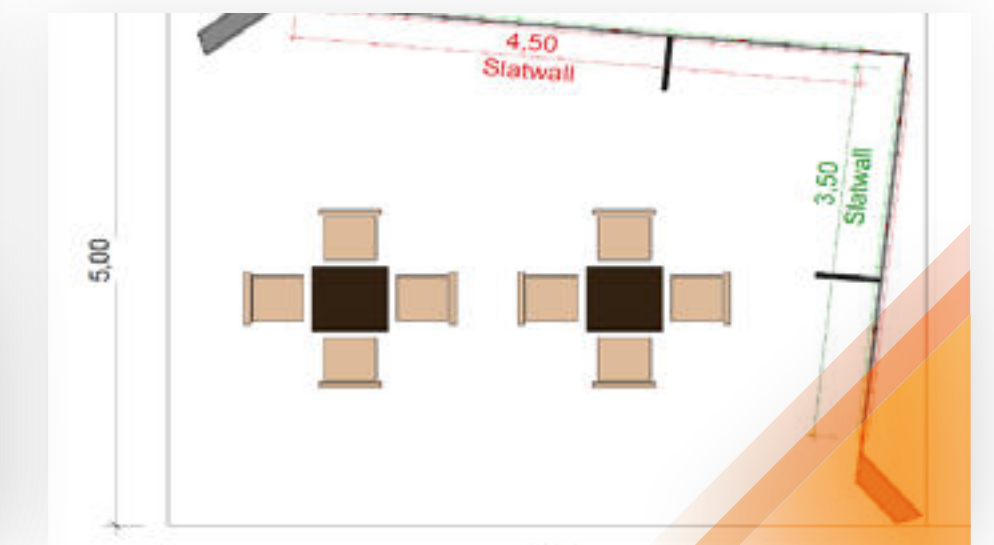

## Package

# Full-Service 60 (60sqm)

**19.229,00 EUR**

## Services

- Pre-built system POLYGON 1,80 m
- 2 Power sockets
- IP connection - symmetrical 10 Mbit/s
- no carpet - tape outline
- 1 Graphic space / Flap 160 cm
- Fixings at choice according to catalog/additional costs
- 2 Seating groups
- 1 Monitor 40" for memystick
- 1 standard typo company name
- Lighting
- including AUMA fee & Stand cleaning

## Tickets

Access to Invitation Tool  
„Connect by ISPO“  
with **unlimited ticket** voucher  
**4 Exhibitor passes**

## Obligatory Communication fee

Basic entry in the digital exhibitor listings „Company profile“ including company name, address, website, four entries in the product index

Company profile and filter options according to products

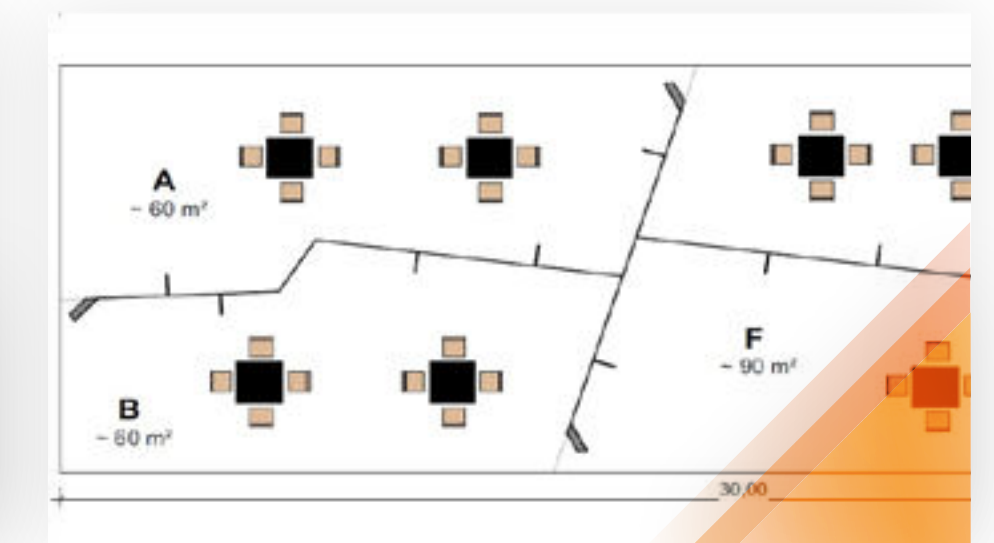

## Package

# Full-Service 90 (60sqm)

**27.229,00 EUR**

## Services

- Pre-built system POLYGON 1,80 m
- 3 Power sockets
- IP connection - symmetrical 10 Mbit/s
- no carpet - tape outline
- 2 Graphic space / Flap 160 cm
- Fixings at choice according to catalog/additional costs
- 3 Seating groups
- 1 Monitor 40" for memystick
- 1 standard typo company name
- Lighting
- including AUMA fee & Stand cleaning

## Tickets

Access to Invitation Tool  
„Connect by ISPO“  
with **unlimited ticket** voucher  
**6 Exhibitor passes**

## Obligatory Communication fee

Basic entry in the digital exhibitor listings „Company profile“ including company name, address, website, four entries in the product index

Company profile and filter options according to products

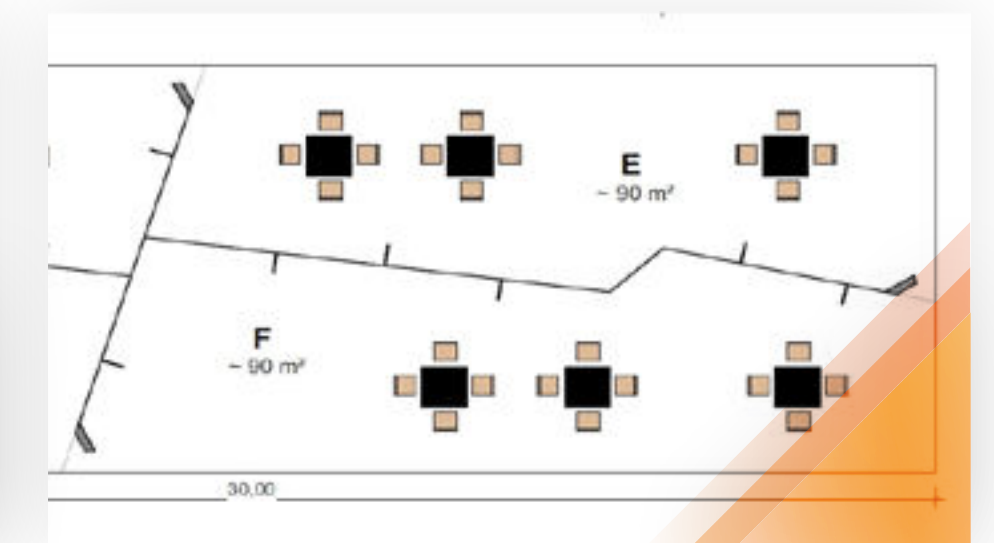

## Package

# Full-Service 30 „Apparel“ (30sqm)

**12.529,00 EUR**

## Services

- Pre-built system Apparel
- Floor graphic
- 1 Power socket
- IP connection - symmetrical 10 Mbit/s
- Tape - outline
- Bambus and Felt sustainable system
- Partition curtain
- 1 Table „invisible“
- Graphic field table surface/ panels
- 4 Chair Juliette
- 1 Sideboard vintage colored
- 2 Clothes rail black
- Lighting
- including AUMA fee & Stand cleaning

## Tickets

Access to Invitation Tool  
„Connect by ISPO“  
with **unlimited ticket** voucher  
**3 Exhibitor passes**

## Obligatory Communication fee

Basic entry in the digital exhibitor listings „Company profile“ including company name, address, website, four entries in the product index

Company profile and filter options according to products

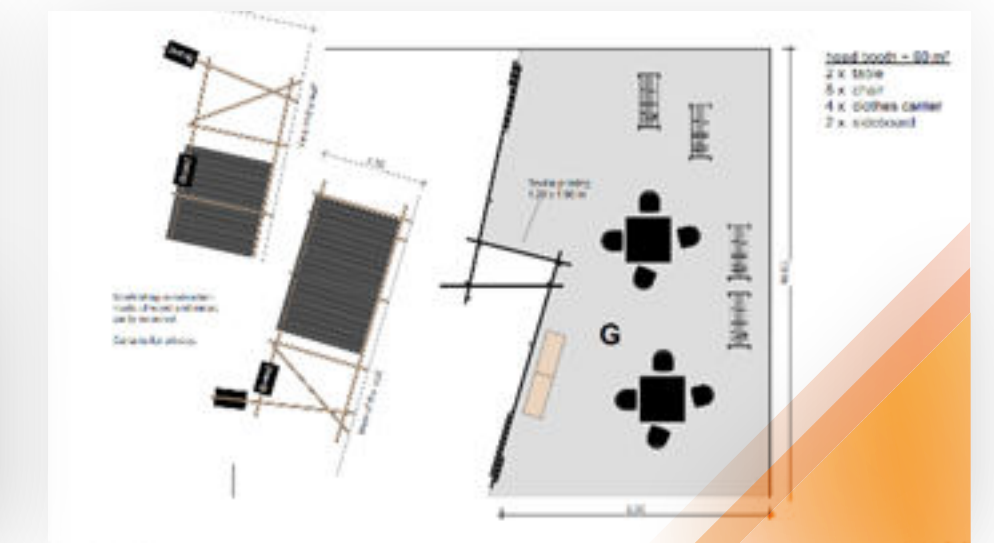

## Package

# Full-Service 60 „Apparel“ (60sqm)

**21.929,00 EUR**

## Services

- Pre-built system Apparel
- Floor graphic
- 1 Power socket
- IP connection - symmetrical 10 Mbit/s
- Tape - outline
- Bambus and Felt sustainable system
- Partition curtain
- 2 Table „invisible“
- Graphic field table surface/ panels
- 8 Chair Juliette
- 1 Sideboard vintage colored
- 4 Clothes rail black
- Lighting
- including AUMA fee & Stand cleaning

## Tickets

Access to Invitation Tool  
„Connect by ISPO“  
with **unlimited ticket** voucher  
**4 Exhibitor passes**

## Obligatory Communication fee

Basic entry in the digital exhibitor listings „Company profile“ including company name, address, website, four entries in the product index

Company profile and filter options according to products

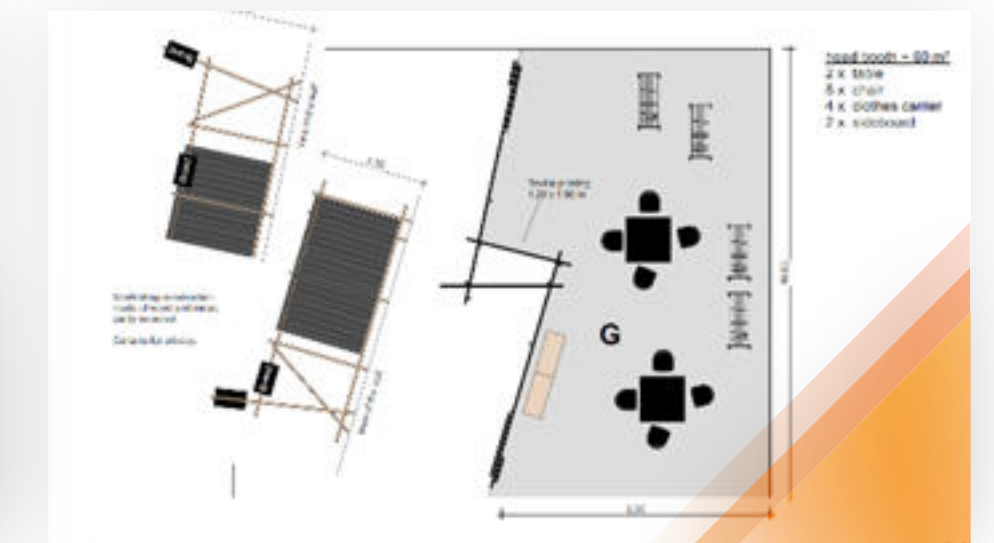
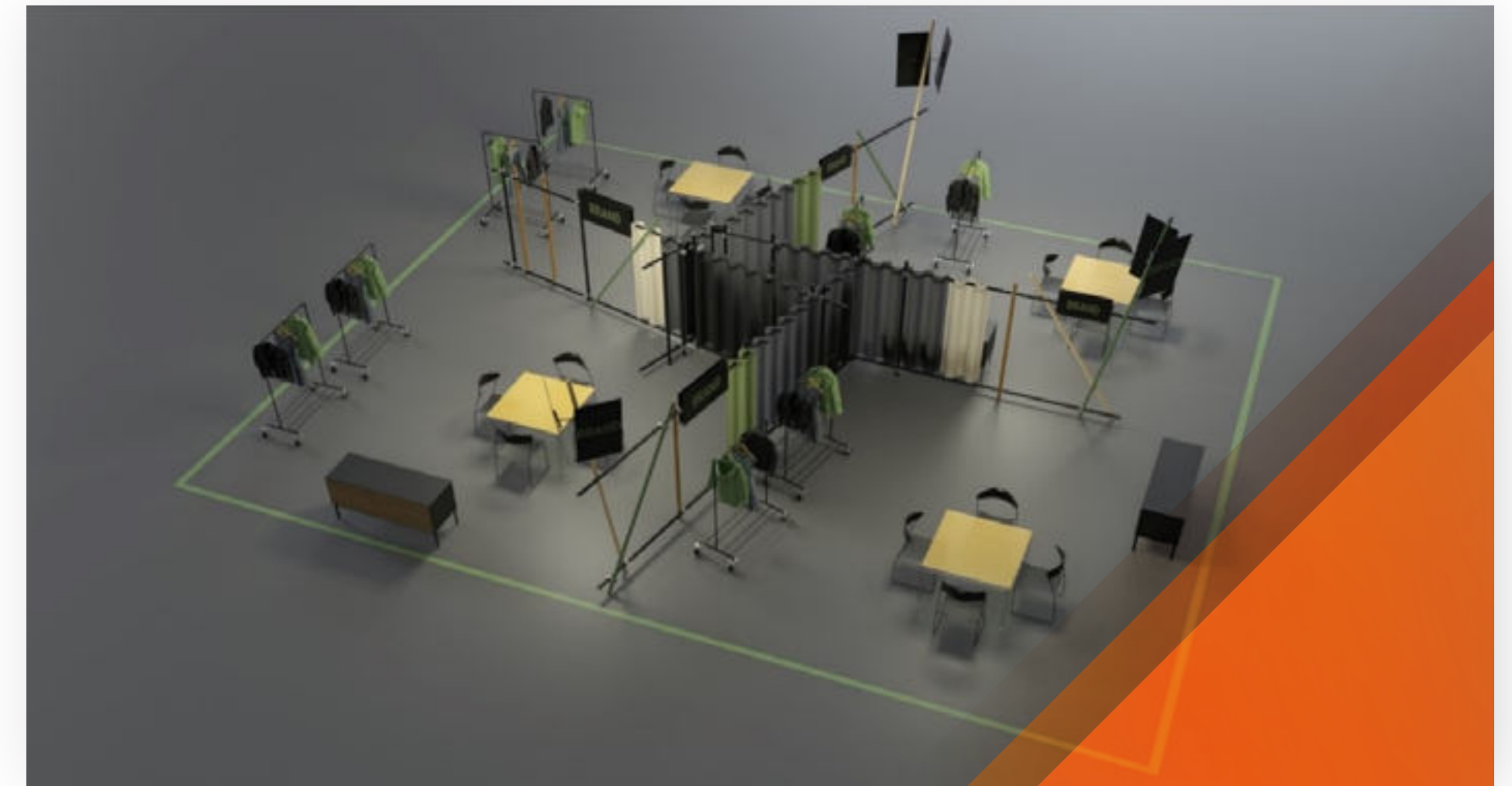



## Package

# Full-Service „Start-Ups“ (4sqm)

**1.999,00 EUR**

## Services

- Pre-built system POLYGON 1,60 m
- Floor graphic
- LED Modul / Memorystick nonstop
- Electricity (3kWh)
- IP connection - symmetrical 10 Mbit/s
- Carpet
- POLYGON facade 1.60 with 2x graphic field
- 1 Fixing at choice according to catalog
- 1 Seating groups
- 1 Graphic field
- including AUMA fee & Stand cleaning

## Tickets

Access to Invitation Tool  
„Connect by ISPO“  
with **unlimited ticket** voucher  
**3 Exhibitor passes**

## Obligatory Communication fee

Basic entry in the digital exhibitor listings „Company profile“ including company name, address, website, four entries in the product index

Company profile and filter options according to products

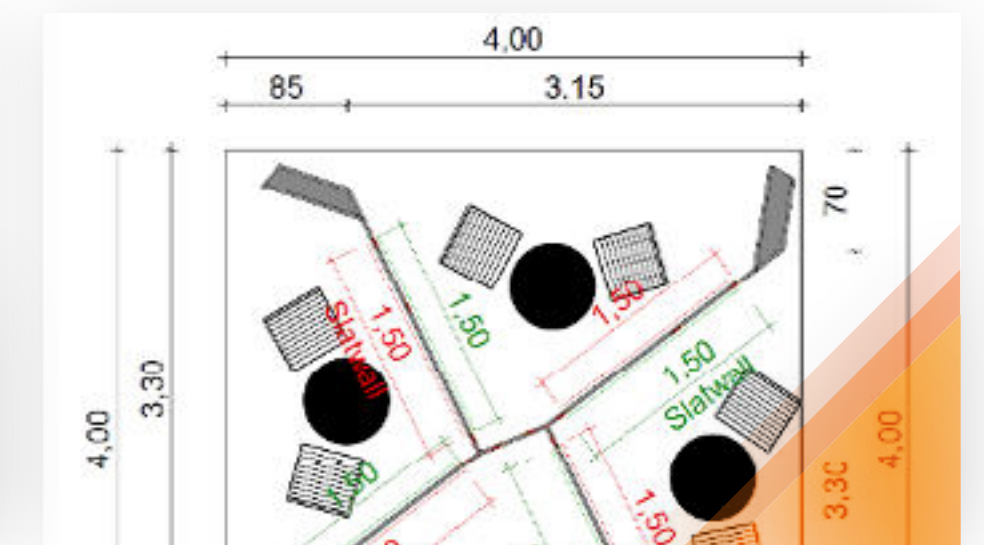
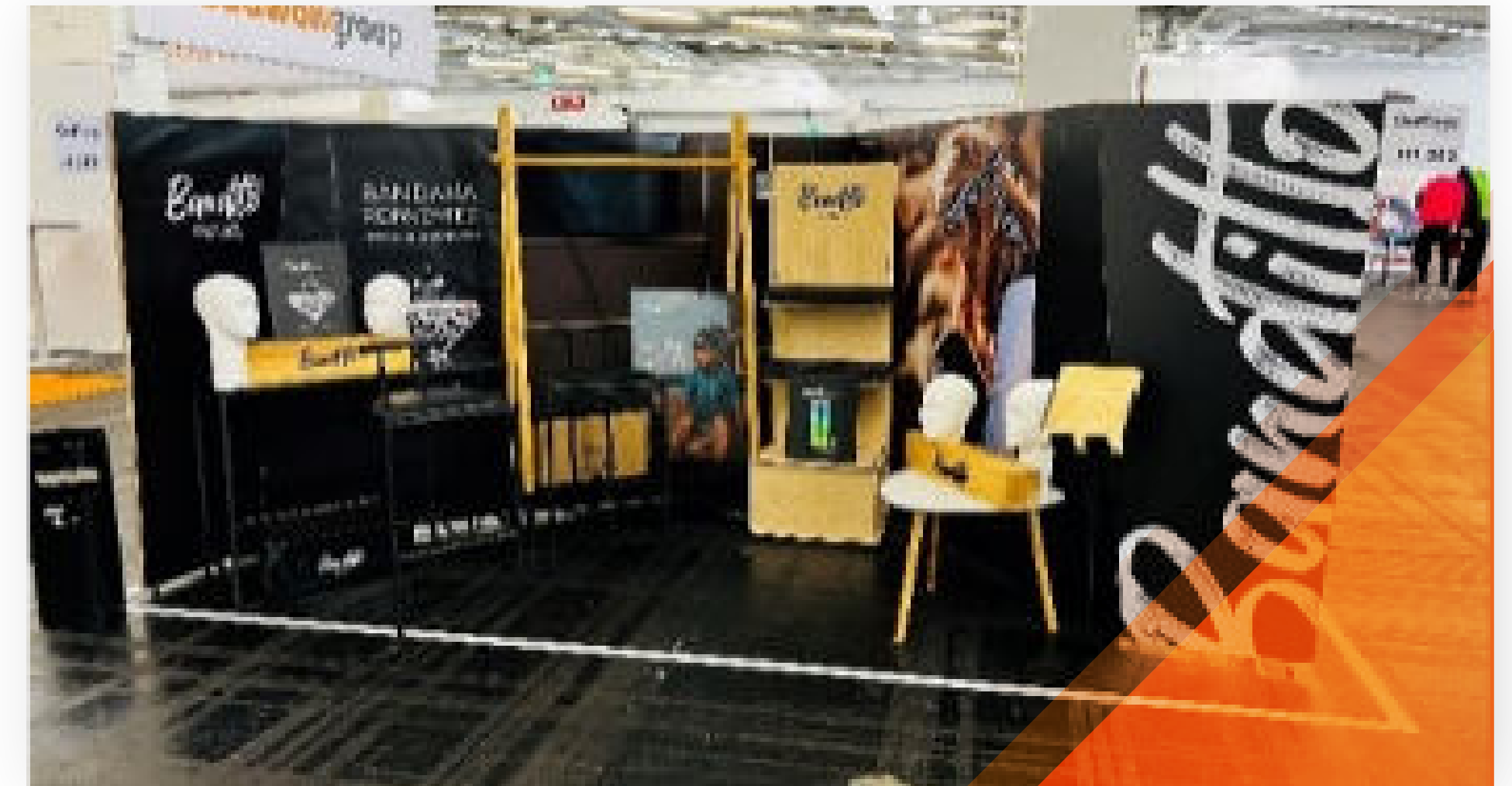

Contact information

# Get in touch



**Lena Haushofer**  
Exhibition Director

[outdoor@messe-muenchen.de](mailto:outdoor@messe-muenchen.de)



**Veronika Gstöttl**  
Category Manager OutDoor

[Veronika.Gstoetl@Messe-Muenchen.de](mailto:Veronika.Gstoetl@Messe-Muenchen.de)



**ARNO Design**  
Stand Builder

[prebuilt-outdoor@arno-design.de](mailto:prebuilt-outdoor@arno-design.de)

**OutDoor**  
by ISPO